

EVERLIGHT

MV53164, MV54164, MV57164 Yellow, High Efficiency Green, High Efficiency Red Bargraph Displays

Features

- Large segment, closely spaced
- End-stackable
- Fast switching—excellent for multiplexing
- Low power consumption
- Directly compatible with IC's
- Wide viewing angle
- Standard .3-inch DIP lead spacing
- Categorized for Luminous Intensity (See Note 1)

Description

The MV5X164 series is a 10 segment bargraph display with separate anodes and cathodes for each light segment. The packages are end-stackable.

Package Dimensions

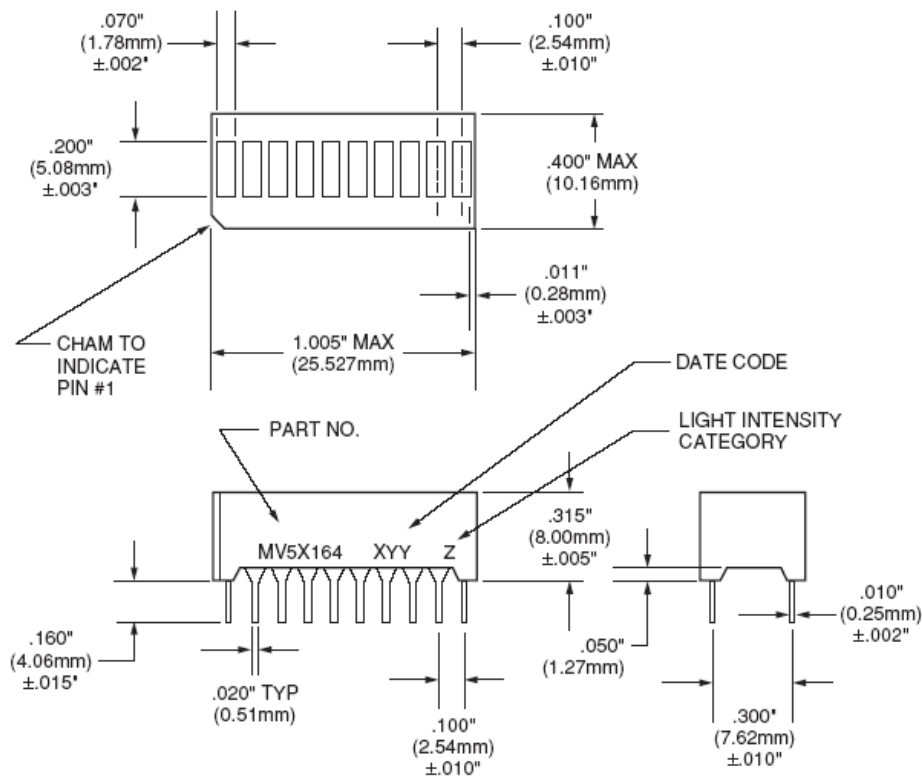

NOTE: Tolerances ±0.10" unless otherwise specified.

MV53164, MV54164, MV57164 Yellow, High Efficiency Green, High Efficiency Red Bargraph Displays

Absolute Maximum Ratings

Parameter	MV53164	MV54164	MV57164
Power dissipation at 25°C ambient	750 mW	750 mW	750 mW
Derate linearly from 50°C	-14.3 mW/°C	-14.3 mW/°C	-14.3 mW/°C
Storage and operating temperature	-40°C to +85°C	-40°C to +85°C	-40°C to +85°C
Continuous forward current			
Total	200 mA	300 mA	300 mA
Per segment	25 mA	30 mA	30 mA
Reverse voltage			
Per segment	6.0 V	6.0 V	6.0 V
Soldering time at 260°C (See Notes 3 and 5)	5 sec.	5 sec.	5 sec.

Typical Thermal Characteristics

Parameter	MV53164	MV54164	MV57164
Thermal resistance junction to free air Φ_{JA}	160°C/W	160°C/W	160°C/W
Wavelength temperature coefficient (case temp.)	1.0 A/°C	1.0 A/°C	1.0 A/°C
Forward voltage temperature coefficient	-1.5 mV/°C	-1.4 mV/°C	-2.0 mV/°C

Electro-Optical Characteristics (25°C Free Air Temperature Unless Otherwise Specified)

Parameter	Test Conditions	Min.	Typ.	Max.	Units
Forward voltage MV53164, MV57164/MV54164	$I_F = 10$ mA		2.0/2.2	2.5/3.0	V
Luminous Intensity (unit average) (See Note 1)	$I_F = 10$ mA	510	1800		μ cd
Pulsed Luminous Intensity (MV54164)	$I_F = 60$ mA, peak; 1:6 DF	710	2500		μ cd
Peak emission wavelength					
MV53164			585		nm
MV54164			562		nm
MV57164			630		nm
Spectral line half width			40/30		nm
Dynamic resistance Segment	$I_F = 20$ mA		26/12		Ω
MV53164, MV57164/MV54164					
Capacitance MV53164, MV57164/MV54164	$V = 0, f = 1$ MHz		35/40		pF
Switching time	$I_F = 10$ mA		500		ns
Reverse voltage	$I_R = 100$ μ A	6.0			

Typical Drive Circuit

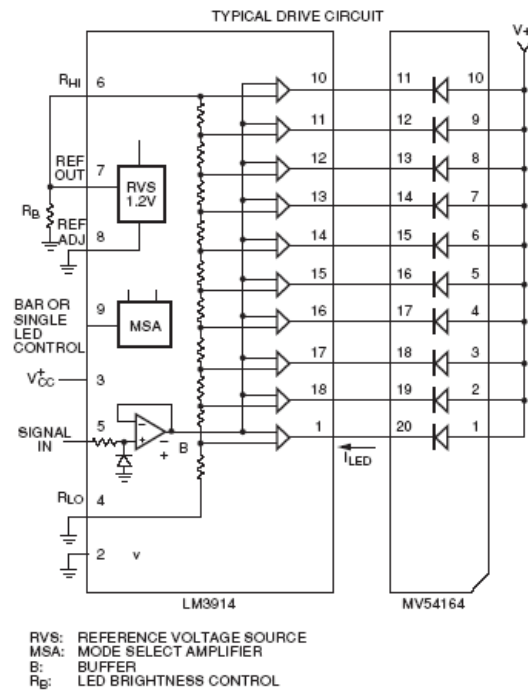

Pin Connections

Pin No.	Electrical Connections	Pin No.	Electrical Connections	Pin No.	Electrical Connections	Pin No.	Electrical Connections
1	Bar 1 Anode	6	Bar 6 Anode	11	Bar 10 Cathode	16	Bar 5 Cathode
2	Bar 2 Anode	7	Bar 7 Anode	12	Bar 9 Cathode	17	Bar 4 Cathode
3	Bar 3 Anode	8	Bar 8 Anode	13	Bar 8 Cathode	18	Bar 3 Cathode
4	Bar 4 Anode	9	Bar 9 Anode	14	Bar 7 Cathode	19	Bar 2 Cathode
5	Bar 5 Anode	10	Bar 10 Anode	15	Bar 6 Cathode	20	Bar 1 Cathode

Typical Curves MV53164, MV54164, MV57164 (Per Segment) (25°C Free Air Temperature)

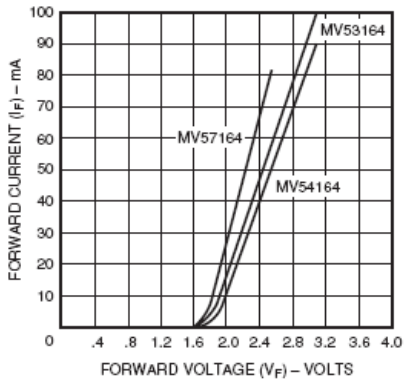

Fig. 1. Forward Current vs. Forward Voltage

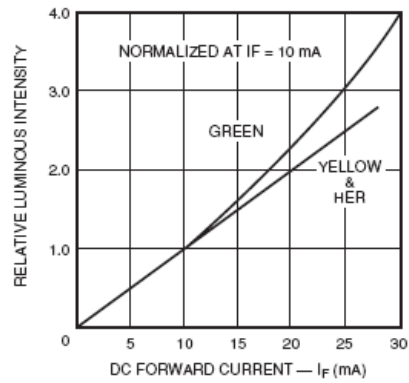

Fig. 2. Relative Luminous Intensity vs. DC Forward Current (Both LED Chips ON)

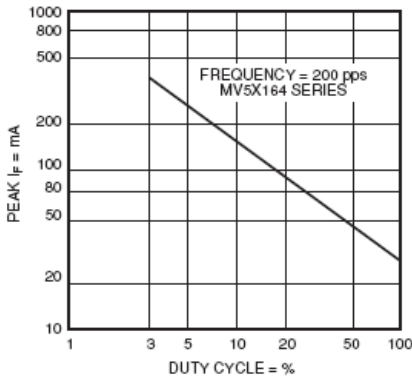

Fig. 3. Max Peak Current vs. Duty Cycle

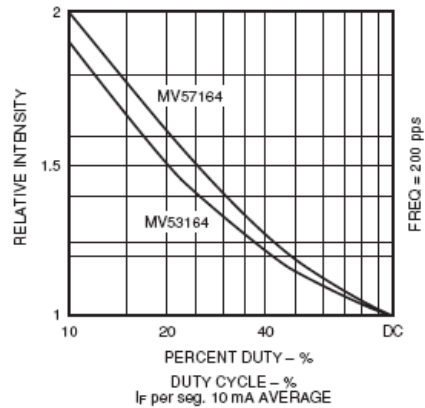

Fig. 4. Luminous Intensity vs. Duty Cycle

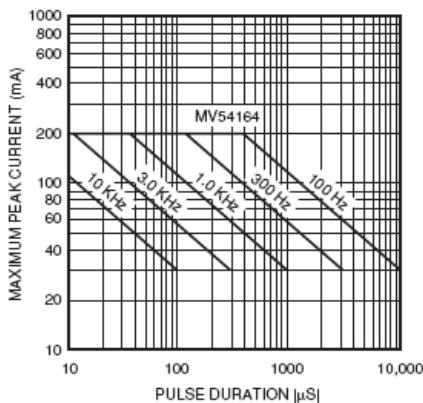

Fig. 5. Maximum Peak Current vs. Pulse Duration

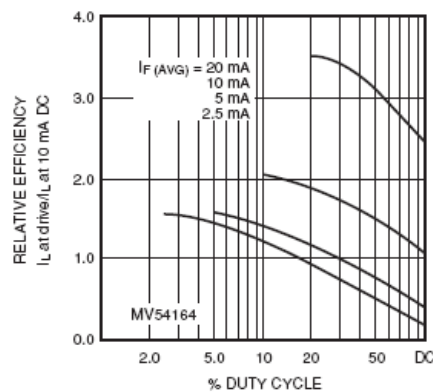

Fig. 6. Relative Efficiency vs. Duty Cycle

Filter Recommendations

For optimum ON and OFF contrast, one of the following filters or equivalents may be used over the lamp:

MV53164
Panelgraphic Yellow 25 or Amber 23
Homalite 190—1720 or 100—1726

MV54164
Panelgraphic Green 48
Homalite 100—1440 Green

MV57164
Panelgraphic Red 60
Homalite 100—1605

In situations of high ambient light, a neutral density filter can be used to achieve greater contrast:

Panelgraphic Grey 10

Panelgraphic Grey 10
Homalite 100—1266 Grey

Notes

1. The average Luminous Intensity is obtained by summing the Luminous Intensity of each segment and dividing by the total number of segments. The standard of measurement is the Photo Research Corp. "Spectra" Microcandela Meter (Model IV-D) corrected for wavelength. Intensity will not vary more than $\pm 33.3\%$ between all segments within a unit.
2. Leads immersed to 1/16 inch (1.6 mm) from the body of the device. Maximum unit surface temperature is 140°C.
3. All units are categorized for Luminous Intensity. The Intensity category is marked on each part as a suffix letter to the part number.
4. For flux removal, Freon TF, Freon TE, isoproponal or water may be used to their boiling points.

TRADEMARKS

The following are registered and unregistered trademarks Fairchild Semiconductor owns or is authorized to use and is not intended to be an exhaustive list of all such trademarks.

ACE ^x TM	FAST [®]	IntelliMAX TM	POP TM	SPM TM
ActiveArray TM	FAST ^r TM	ISOPLANAR TM	Power247 TM	Stealth TM
Bottomless TM	FPST TM	LittleFET TM	PowerEdge TM	SuperFET TM
CoolFET TM	FRFET TM	MICROCOUPLER TM	PowerSaver TM	SuperSOT TM -3
CROSSVOLT TM	GlobalOptoisolator TM	MicroFET TM	PowerTrench [®]	SuperSOT TM -6
DOME TM	GTO TM	MicroPak TM	QFET [®]	SuperSOT TM -8
EcoSPARK TM	HiSeC TM	MICROWIRE TM	QS TM	SyncFET TM
E ² CMOS TM	PC TM	MSX TM	QT Optoelectronics TM	TinyLogic [®]
EnSigna TM	i-Lo TM	MSXPro TM	Quiet Series TM	TINYOPTO TM
FACT TM	ImpliedDisconnect TM	OCX TM	RapidConfigure TM	TruTranslation TM
FACT Quiet Series TM		OCXPro TM	RapidConnect TM	UHC TM
Across the board. Around the world. TM		OPTOLOGIC [®]	µSerDes TM	UltraFET [®]
The Power Franchise [®]		OPTOPLANAR TM	SILENT SWITCHER [®]	UniFET TM
Programmable Active Droop TM		PACMAN TM	SMART START TM	VCX TM

DISCLAIMER

FAIRCHILD SEMICONDUCTOR RESERVES THE RIGHT TO MAKE CHANGES WITHOUT FURTHER NOTICE TO ANY PRODUCTS HEREIN TO IMPROVE RELIABILITY, FUNCTION OR DESIGN. FAIRCHILD DOES NOT ASSUME ANY LIABILITY ARISING OUT OF THE APPLICATION OR USE OF ANY PRODUCT OR CIRCUIT DESCRIBED HEREIN; NEITHER DOES IT CONVEY ANY LICENSE UNDER ITS PATENT RIGHTS, NOR THE RIGHTS OF OTHERS.

LIFE SUPPORT POLICY

FAIRCHILD'S PRODUCTS ARE NOT AUTHORIZED FOR USE AS CRITICAL COMPONENTS IN LIFE SUPPORT DEVICES OR SYSTEMS WITHOUT THE EXPRESS WRITTEN APPROVAL OF FAIRCHILD SEMICONDUCTOR CORPORATION. As used herein:

1. Life support devices or systems are devices or systems which, (a) are intended for surgical implant into the body, or (b) support or sustain life, or (c) whose failure to perform when properly used in accordance with instructions for use provided in the labeling, can be reasonably expected to result in significant injury to the user.

2. A critical component is any component of a life support device or system whose failure to perform can be reasonably expected to cause the failure of the life support device or system, or to affect its safety or effectiveness.

PRODUCT STATUS DEFINITIONS

Definition of Terms

Datasheet Identification	Product Status	Definition
Advance Information	Formative or In Design	This datasheet contains the design specifications for product development. Specifications may change in any manner without notice.
Preliminary	First Production	This datasheet contains preliminary data, and supplementary data will be published at a later date. Fairchild Semiconductor reserves the right to make changes at any time without notice in order to improve design.
No Identification Needed	Full Production	This datasheet contains final specifications. Fairchild Semiconductor reserves the right to make changes at any time without notice in order to improve design.
Obsolete	Not In Production	This datasheet contains specifications on a product that has been discontinued by Fairchild semiconductor. The datasheet is printed for reference information only.